

Notes on

Nuclear and Elementary Particle Physics

Daniel F. Styer; Schiffer Professor of Physics; Oberlin College

Copyright © 14 January 2022

Abstract: Even in intricate situations where closed-form solutions are unavailable, relativity and quantum mechanics combine to provide qualitative explanations for otherwise inexplicable phenomena.

The copyright holder grants the freedom to copy, modify, convey, adapt, and/or redistribute this work under the terms of the Creative Commons Attribution Share Alike 4.0 International License. A copy of that license is available at <http://creativecommons.org/licenses/by-sa/4.0/legalcode>.

Contents

1	Characteristics of Nuclei	3
2	Radioactivity	9
3	“Something Is Missing”	13
4	Nuclear Stability	19
5	Balance of Masses	26
6	Elementary Particles	27
7	Epilogue	38

Chapter 1

Characteristics of Nuclei

Contents. A nucleus is made up of protons and neutrons. (The word “nucleon” means “either a proton or a neutron”. Nucleons are spin- $\frac{1}{2}$ fermions.) For example, one isotope of carbon has 6 protons and 8 neutrons. This nucleus is called carbon-14 and denoted by



The number of protons, in this case 6, is called the “atomic number” Z . (The symbol Z originates from the German “Zahl”, meaning “number”.) The total number of nucleons, in this case 14, is called the “mass number” A . It is called “mass number” because the mass of the nucleus is nearly A times the mass of a proton. This relation is not exactly true because (1) a neutron is slightly more massive (about 0.14% more) than a proton and (2) as we learned in relativity, the mass of the nucleus is slightly less than the sum of the masses of its constituents.

Mass. Most of the mass of an atom is contributed by its nucleus. The masses of nuclei and atoms are usually presented, not in kilograms (kg), but in “atomic mass units” (u). One atomic mass unit is about the mass of a hydrogen atom. (The exact definition is “one-twelfth the mass of a free [unbound] carbon-12 atom in its ground state”.)

You know that the mass of an object is not equal to the sum of the masses of its constituents, but typical electronic energies are so small that this relativistic effect can be ignored. (This is *not* true for typical nuclear energies.) Thus to very high accuracy, the mass of a ${}^{14}_6\text{C}$ atom is *equal to* the mass of a ${}^{14}_6\text{C}$ nucleus plus 6 times the mass of an electron. Whereas the mass of a ${}^{14}_6\text{C}$ nucleus is *less than* 6 times the mass of a proton plus 8 times the mass of a neutron.

Size. You can't measure the size of a nucleus with Vernier calipers. Rutherford¹ thought of a different way. He bombarded a gold foil, made up of $^{197}_{79}\text{Au}$, with α particles. (The α particle is a helium nucleus ^4_2He .)

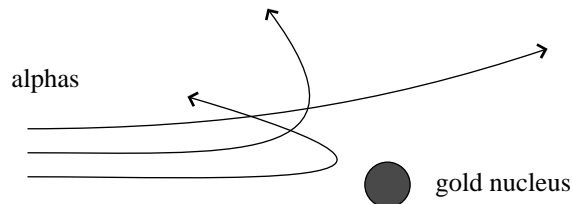

He found that at typical energies, the alphas scattered off the nuclei with the pattern calculated for two charged point particles, interacting through Coulomb's law, with charges $q_\alpha = +2e$ and $q_{\text{Au}} = +79e$. None of the alphas go "inside" the gold nucleus, which explains why both behave like points.

But if the energy of the alphas is increased, at one point the observed scattering pattern differs from the calculated. When this happens Rutherford knew that the alpha went "inside" the gold nucleus, and knowing the energy at which deviations occurred he could calculate how close the alpha approached, and hence how big a nucleus was.

He found that a typical nuclear size was about a femtometer, 10^{-15} m, and a size this small is hard to conceive. I think of the wavelength of light as small. But an atom is smaller still and a nucleus is far smaller again. Typical sizes are:

wavelength of light	400 nm
atom	0.1 nm
nucleus	0.000 001 nm

For comparison, here are three other objects with the same size ratio:

continent of North America	4000 km
town of Oberlin	1 km
thumbnail	0.000 01 km = 1 cm

Sometimes people say that a nucleus inside an atom is like a fly inside a cathedral. It's really tiny.

The radii of numerous different nuclei have been measured in this manner. They approximately fit the formula

$$r = (1.2 \text{ fm})A^{1/3} \quad (1.1)$$

¹Ernest Rutherford, 1871–1937, New Zealand-born British experimental physicist who pioneered nuclear physics.

where A , recall, is the number of nucleons. Thus the volume of the nucleus is (at this level of approximation) directly proportional to A . This would be the same approximate formula obtained if protons and neutrons were marbles, each of radius 1.2 fm, and they were packed tightly touching each other to make a roughly spherical nucleus. Do not read too much into this story: nucleons are not marbles, and the formula is not exact. But it does make a readily memorable picture, very different from the picture of electrons in an atom, which is mostly empty space.

Interactions. Positively charged protons repel. So why does the nucleus hold together? There must be some non-electric force that holds them together. What force?

Gravity is too weak to hold together ordinary nuclei. (Although it is responsible for holding together neutron stars, which are atomic nuclei kilometers in size. None of these occur near the earth!)

Springs, glue, and rubber bands provide attractive forces, but the nucleus doesn't contain glue. Instead glue is made up of nuclei! This is a good metaphor but nothing more.

To there must be some other interaction aside from the familiar gravity and contact forces of introductory mechanics. It is called the "strong nuclear force" or just the "strong force".

Characteristics of the strong force. The strong force doesn't affect electrons, but it does affect protons and neutrons. Furthermore, it affects neutrons and protons in almost exactly the same way. (You can prove this experimentally by scattering α particles from a series of nuclei with different numbers of protons and neutrons but all with the same number of nucleons: for example ${}_{43}^{93}\text{Tc}$, ${}_{42}^{93}\text{Mo}$, ${}_{41}^{93}\text{Nb}$, ${}_{40}^{93}\text{Zr}$, and ${}_{39}^{93}\text{Y}$. All these nuclei scatter α particles in almost exactly the same way, and calculation shows that that these small differences are accounted for through the electrostatic repulsion, which *does* differ from nucleus to nucleus.)

The obvious question now is: What is the force law for nucleon-nucleon attraction due to the strong force? The gravitational force varies like $1/r^2$, and the electrostatic force varies like $1/r^2$, and the magnetic force varies like $1/r^2$, so a good guess is that the strong force does as well. This guess is absolutely wrong.

First of all, in relativistic situations any force that depends upon separation r alone must be false, because such forces change instantly when the separation distance changes. Second, experiment shows that the strong force depends not only on the separation between the two nucleons but also on their spins. (Neutrons and protons are both spin- $\frac{1}{2}$ particles.) Third, even in the non-relativistic limit there is no simple formula. The so-called Reid potential energy function² of 1968 is still widely used as

²Which builds on work by Hideki Yukawa, 1907–1981, Japanese theoretical physicist who showed

an approximate model. When the two nuclear spins are in the singlet spin state,

$$V_{\text{Reid}}(r) = -10.463 \frac{e^{-\mu r}}{\mu r} - 1650.6 \frac{e^{-4\mu r}}{\mu r} + 6484.2 \frac{e^{-7\mu r}}{\mu r} \quad (1.2)$$

where $\mu = 0.7 \text{ fm}^{-1}$ and where the potential energy is given in units of MeV.

The force associated with this potential energy function is

$$\vec{F}_{\text{Reid}}(r) = -\frac{dV_{\text{Reid}}(r)}{dr} \hat{r}, \quad (1.3)$$

plotted below

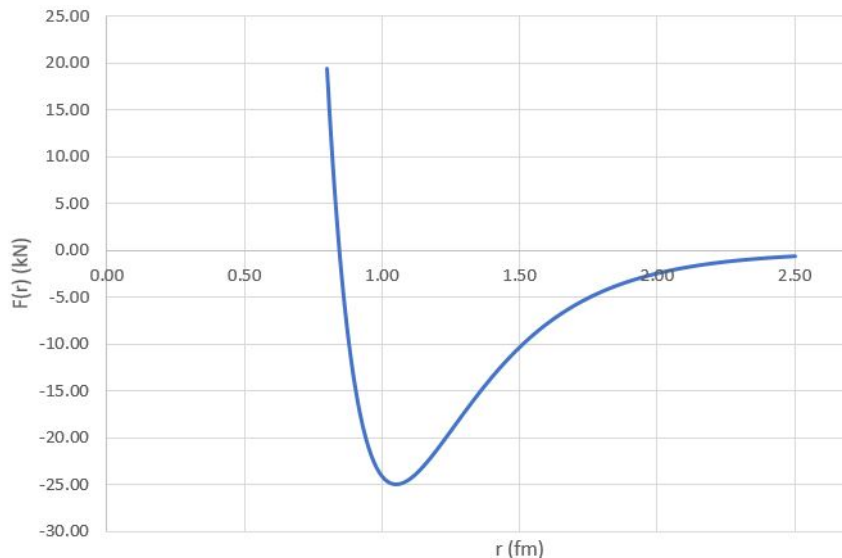

The attractive (negative) force has a maximum when the nucleon separation is about 1.1 fm, in which case the force is about 25 000 N. A pair of nucleons closer than about 0.8 fm experience a large repulsive (positive) force.

Caveat. At the beginning of this chapter, I said the carbon-14 nucleus was denoted by



You should know that this symbol is sometime used to represent the carbon-14 nucleus (six protons plus eight neutrons) and sometime used to represent the carbon-14 atom (six protons plus eight neutrons plus six electrons). Often it doesn't make much difference, because electrons have such small masses and carry such small energies, relative to the nucleus. But they do possess comparable amounts of charge. You need to figure out from context whether this symbol is used to represent the nucleus or the atom.

that most relativistically correct force laws would, in the classical limit, have a potential energy function of the form $e^{-(\text{constant})r}/r$. (For gravity and electromagnetism, the constant is zero.) See R.V. Reid, "Local phenomenological nucleon-nucleon potentials" *Annals of Physics* **50** (1968) 411-448, equation (16).

Problems

- 1.1 The text described finding the size of a gold nucleus by bombarding with alpha particles of increasing energy. As the energy increases, which alphas first show a deviation from point-repulsive electrostatic behavior?
- 1.2 A force of 25 000 N, acting on a proton, produces what acceleration? Compare to 9.8 m/s^2 .
- 1.3 **Strong force vs. electrostatic force**

- a. Show that the electrostatic repulsion between two protons is

$$+(2.3071 \times 10^{-28} \text{ N} \cdot \text{m}^2) \frac{1}{r^2} \hat{r}. \quad (1.4)$$

- b. Show that for large values of r , the Reid force (in units of MeV/fm) is approximately

$$-10.463 \frac{e^{-\mu r}}{r} \hat{r}. \quad (1.5)$$

Coulomb's law tells the full story of the electrostatic force. This formula tells only a partial story of the strong force: it holds only for parallel spins at large separations, for example. Nevertheless it allows comparisons to be made.

- c. Show that the force (1.5), converted to Newtons, is

$$-(1.6764 \times 10^{-12} \text{ N} \cdot \text{m}) \frac{e^{-\mu r}}{r} \hat{r}. \quad (1.6)$$

- d. At what distance are the electrostatic force and the approximation (1.6) for the strong force equal in magnitude? (You will need to numerically solve a transcendental equation. Use the larger solution.)
- e. What are the magnitudes of these two forces at twice this distance? Half?

While both the strong nuclear force and the electrostatic force fall to zero as the separation grows large, the strong nuclear force does so much more rapidly.

- 1.4 **Neutron star.** A neutron star is a glob of pure neutrons. Such stars do not shine with visible light, but they can be strong radio emitters called pulsars. A typical neutron star has the mass of 1.4 suns.
- a. What is the radius of such a typical neutron star? (This radius is very large for a nucleus, but very small for a star.)
- b. Any uniform spherical object will have a gravitational potential energy that can depend only upon its mass M , its radius R , and Newton's gravitational constant G . Using dimensional analysis, find a formula for the gravitational potential energy that is valid up to some unknown dimensionless factor.

- c. Use these results to estimate the gravitational potential energy of a neutron star. (In addition, there will also be energy due to the strong nuclear interaction acting between neutrons.)

Chapter 2

Radioactivity

Some nuclei are stable and last for as long as anyone has ever been able to determine. Others break down.

When an atom breaks down, it does so by emitting an photon (usually) or sometimes an electron (named¹ the “Auger effect”).

But nuclei decay in three different ways: First of all some nuclei emit gamma particles. A gamma is just a photon, but it comes from a smaller source than an atom, hence has a smaller wavelength, and hence a larger energy $E = hc/\lambda$. (Recall that $hc = 1240 \text{ eV}\cdot\text{nm}$.) This is the same sort of thing as an atom ejecting a photon: it signifies that the internal components of the nucleus rearrange, but they do not change. An example of gamma decay is

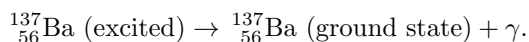

A barium-137 nucleus with 56 protons and 81 neutrons emits a gamma. Afterwards it has less energy, but it still has 56 protons and 81 neutrons.

Second, some nuclei break up. Sometimes a nucleus breaks up by ejecting a neutron, or a proton, or by ejecting an alpha particle (a ${}^4_2\text{He}$ nucleus), or by breaking into two pieces of about the same size (“fission”). This is not merely a rearrangement: some of the components that had been within the nucleus are ejected. An example of alpha decay is

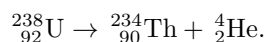

¹This possibility was first discovered by Lise Meitner in 1922; Pierre Victor Auger independently rediscovered it in 1925. Auger was French, so this effect is pronounced “O-jei”. Lise Meitner (1878–1968) was an Austrian-Swedish physicist who discovered this effect, and the energy range of beta particles, and the element protactinium, and nuclear fission. She deserved one or more Nobel Prizes, and was nominated 48 times, but never received it. In 1997, twenty-nine years after her death, element 109 was named meitnerium in her honor.

The uranium-238 nucleus loses 2 protons and 2 neutrons to form thorium-234. It emits an alpha particle (which consists of 2 protons plus 2 neutrons). An example of fission is

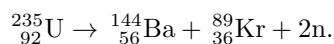

Third, some nuclei emit electrons, which in this context are called beta particles. This is highly mysterious, because there are no electrons in the nucleus to begin with! An example of beta decay is

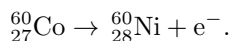

The cobalt-60 nucleus changes to nickel-60 — same number of nucleons, but one neutron changes to a proton, which balances the charge of the emitted electron.

Perhaps you know that the electron (like all fermions) has a twin: a particle with the same mass, same spin, and same amount of charge but opposite sign of charge. This twin is called a positron (or an anti-electron). Some nuclei decay by emitting a positron, which is called beta plus decay. An example is

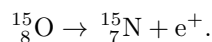

In beta plus decay the number of nucleons doesn't change, but one proton changes to a neutron. Once again, charge is conserved.

A process similar to beta plus decay is “electron capture”. A nucleus captures one of the electrons in its atom, thereby changing a proton to a neutron. For example

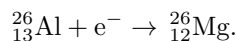

Shielding from radioactivity. Most people know that the alpha, beta, gamma, and other radiation emitted by radioactive nuclei can present health hazards. You should shield yourself from them. Most alpha particles are relatively slow, and they are charged so they are buffeted by other nuclei. They can generally be stopped by nothing more than a sheet of paper. Beta particles are usually faster, and they are also charged so they are again buffeted by nuclei. They can generally be stopped by a thin sheet of steel. Gamma radiation is highly energetic and uncharged, so not subject to electrostatic buffeting. Gammas can be very dangerous, and are stopped by a thick sheet of lead.

Decay rate. The number of decays per second is proportional to the number of radioactive nuclei present:

$$\frac{dN(t)}{dt} = -(\text{constant})N(t).$$

This constant has dimensions of 1/time, so it is called $1/\tau$

$$\frac{dN(t)}{dt} = -\frac{N(t)}{\tau}.$$

You can solve this differential equation in your sleep:

$$N(t) = N(0)e^{-t/\tau}.$$

Remember that $2^x = e^{x \ln(2)}$, so

$$N(t) = N(0)2^{-t/T_{1/2}},$$

where the so-called “half-life” is

$$T_{1/2} = \tau \ln(2) = \tau(0.693).$$

Which nuclei decay in which manner? The graphic below² shows how various nuclei usually decay.

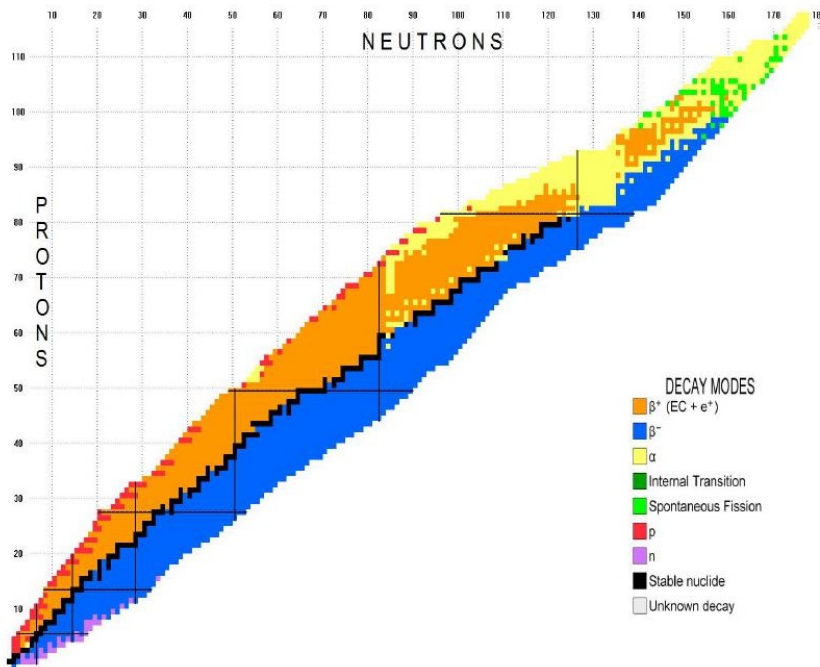

For light stable nuclei, the number of neutrons is about equal to the number of protons. But for heavy stable nuclei, there are *more* neutrons than protons. This observation demands an explanation.

But there’s something even more blatant. The nucleus is held together by the short-range strong force, attracting nucleon to nucleon. It is pulled apart by the long-range electrostatic force, repelling proton from proton. So it makes sense that a nucleus with lots of protons would be unstable. However it seems, from what we’ve

²G. Audi, F.G. Kondev, Meng Wang, W.J. Juang, and S. Naimi, “The NUBASE2016 evaluation of nuclear properties” *Chinese Physics C* **41** (2017) 030001 at page 030001-13.

said so far, that a nucleus with lots of neutrons ought to be very stable, because there's so little electrostatic repulsion. Yet that's not the case: nuclei with lots of neutrons are *not* highly stable. This observation also demands an explanation.

Chapter 3

“Something Is Missing”

In an alpha decay like

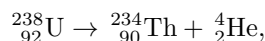

all of the alphas are emitted at the same kinetic energy. Furthermore, that energy corresponds to the difference in mass between ${}_{92}^{238}\text{U}$ and (${}_{90}^{234}\text{Th}$ plus ${}_2^4\text{He}$) through $E = \Delta mc^2$.

But in a beta decay like

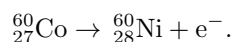

the betas are emitted with a range of kinetic energies, ranging from zero to some maximum. The maximum kinetic energy corresponds to the difference in mass between ${}_{27}^{60}\text{Co}$ and (${}_{28}^{60}\text{Ni}$ plus e^{-}) through $E = \Delta mc^2$. In those situations where the electron is emitted with zero energy, what happens to the missing energy?

This range in energy for the emitted betas was discovered¹ by Lise Meitner and Otto Hahn back in 1911, when the only known particles were electrons, protons, and photons. (It was thought back then that the nucleus ${}_{28}^{60}\text{Ni}$ consisted, not of 28 protons plus 32 neutrons, but of 60 protons plus 32 electrons. Both configurations have a net charge of $+28e$.) Neils Bohr, fond of strange ideas, was ready to “renounce the very idea of energy balance” (Faraday Lecture of 1931).

But in 1930, Wolfgang Pauli thought of a different possibility. He wanted to talk about it at a conference in Tübingen, Germany, but was not able to attend. So on 4 December 1930 he addressed a letter to the “Dear Radioactive Ladies and

¹For historical background, see Laurie M. Brown, “The idea of the neutrino” *Physics Today* **31**, number 9 (September 1978) 23–28 [<https://physicstoday.scitation.org/doi/10.1063/1.2995181>]; and Edoardo Amaldi, “From the discovery of the neutron to the discovery of nuclear fission” *Physics Reports* **111** (September 1984) 1–331 [[https://doi.org/10.1016/0370-1573\(84\)90214-X](https://doi.org/10.1016/0370-1573(84)90214-X); neutrino naming story in footnote 277 on page 306].

Gentlemen” (“Liebe Radioaktive Damen und Herren”) attending. In this letter he proposed that when a beta particle is emitted, the nucleus also emits an electrically uncharged particle of very low mass. He called these particles “neutrons”. The range of electron energies “would then become understandable by the assumption that in beta decay a neutron is emitted in addition to the electron such that the sum of the energies of the neutron and the electron is constant.”

In 1932 James Chadwick discovered the particle that we today call the “neutron”. Enrico Fermi discussed this discovery with his students at the Sapienza University of Rome, and one asked whether Chadwick had discovered the particle postulated by Pauli. No, said Edoardo Amaldi (another of Fermi’s students). Chadwick’s neutron has about the same mass as a proton, whereas Pauli’s postulated particle had to have a very small mass — Pauli’s particle was an “itty-bitty neutral particle”.

Except that Amaldi was speaking in Italian. Most languages (not English) have a “diminutive suffix” indicating a smaller version of the root word. In Italian the diminutive suffix is -ino. The word for cat is “gatto”, the word for kitten is “gattino”. So Amaldi didn’t say “itty-bitty neutral particle”, he said “neutrino”. Ever since then the particle postulated by Pauli has been called a neutrino.

The neutrino would have to interact very weakly with matter. For example, in search of the missing energy you might wrap a beta emitter in lead walls one meter thick. The emitted neutrinos would be absorbed by those lead walls, and the energy they carried away from the beta emitter would increase the temperature of the walls. This experiment was tried, and no temperature increase could be detected. Neutrinos seem to go right through a meter of lead.

In fact, neutrinos are so hard to detect that there was no direct experimental evidence for their existence until 1956, when Clyde Cowan and Fred Reines² discovered them through the reaction

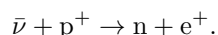

Here $\bar{\nu}$ represents an antineutrino.

What is the interaction responsible for beta decay and similar nuclear reactions?

Is it gravity? No! Gravity is purely attractive and cannot make a nucleus break up.

Is it the electromagnetic force? No! The neutrino is uncharged.

Is it the strong force? No! A nucleus composed solely of neutrons would be very stable if only the strong and electromagnetic forces existed.

Yet it breaks up through beta decay.

²Clyde Cowan (1919–1974) and Fred Reines (1918–1998) were American physicists. The name “Reines” is pronounced with two syllables: ry-nes. For reasons unknown, the Nobel Prize for this discovery was not awarded for thirty-nine years, after Cowan’s death.

The interaction behind beta decay must be yet another force. It is called the “weak nuclear force” or simply the “weak force”.

Characteristics of the weak force

I’m just going to state some results gleaned through much experimental effort.

Which particles does the weak force affect?

	strong	electromagnetic	weak	gravity
proton	×	×	×	×
neutron	×	×	×	×
electron		×	×	×
neutrino			×	×
photon				×

The proton and neutron are affected by all four types of force. (The neutron is electrically neutral, but has a magnetic moment so it feels the magnetic force.) The electron doesn’t feel the strong force. (Similarly for the positron.) The neutrino is uncharged and has no magnetic moment: it doesn’t feel strong or electromagnetic forces. The photon feels only gravity. (The photon is massless, so it would not feel gravity if Newton’s law of gravity were correct. But it *does* carry energy, and Einstein’s law of gravity — also called general relativity — correctly predicts that the path of light bends in gravity.)

What is the range of the weak force? Very short — only about 10^{-3} fm.

How strong is the weak force? As the name suggests, the weak force is very weak. Neutrinos feel only the weak force, not the strong or electromagnetic forces, and we’ve already seen that they can pass unaffected through a meter of lead. In fact, neutrinos from the sun pass right through the center of the earth, then pierce your body and go right out the other side.

I have two more ways to demonstrate the weakness of the weak force. There is a particle called Δ^+ that decays into a proton and a neutral π meson through a reaction intermediated by the strong force:



There is a different particle, called Σ^+ , that decays in exactly the same way, except that the reaction is intermediated by the weak force:



The half lives of both decays are shown. Both of them are very short on a human scale, but that’s irrelevant. What matters is that the first reaction happens 10^{13}

times faster than the second. If the first reaction required four seconds, the second would require 6×10^{13} seconds — almost two million years. A much more powerful force intermediates the first breakup. When I say “weak force”, I’m not kidding.

Second: Because the weak force is so weak, neutrinos are hard to detect. Here’s a photo of a gamma particle detector:



You can hold it in one hand.

Neutrons, being electrically neutral, are harder to detect than protons. The neutron detector show here



requires two hands to lift.

In contrast, the detector at the Sudbury Neutrino Observatory is shown below.

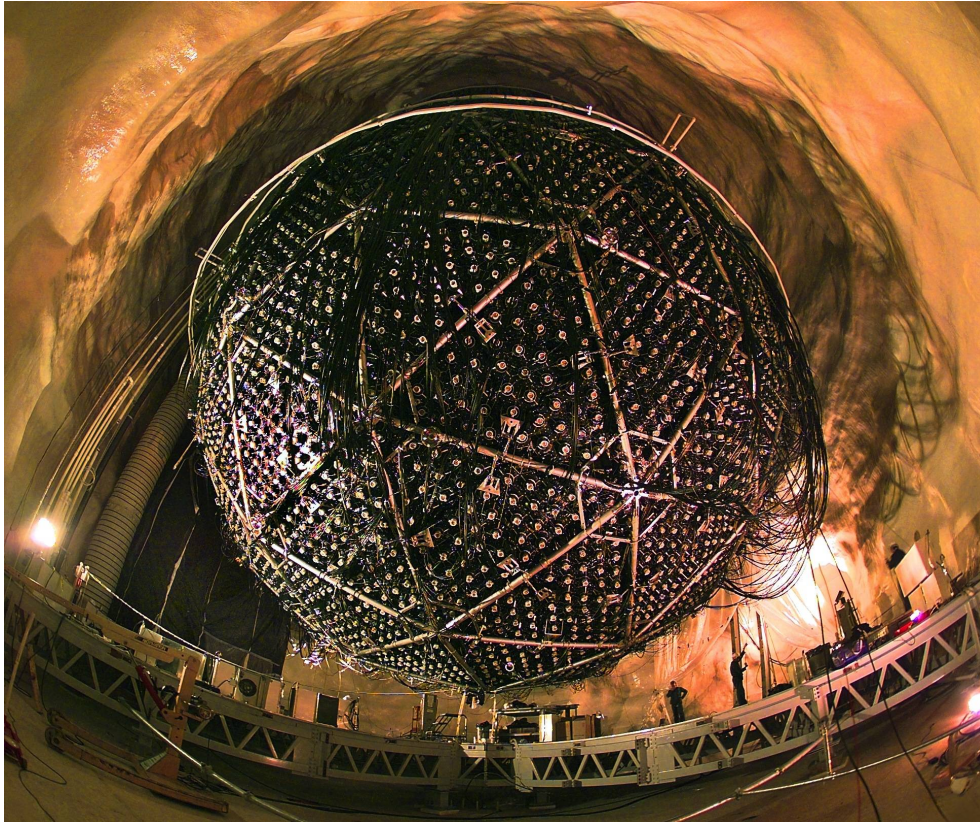

Note the human beings. Neutrinos interact so weakly that you need a lot of stuff if you hope to detect even one.

[[The story I heard was that when Cowan and Reines did their experiment to first detect neutrinos, they rigged their device so that it would set off the building fire alarm whenever it detected a single neutrino. Yet so few neutrinos were detected that the building occupants never became upset.]]

Steven Weinberg³ says that the weak force is so weak, relative to the strong force, that it “does not appreciably affect the structure of the nucleus before the decay occurs; it is like a flaw in a bell of cast metal which has no effect on the ringing of the bell until it finally causes the bell to fall into pieces.”

³“The Forces of Nature” *Bulletin of the American Academy of Arts and Sciences* **29** 13–29 (January 1976).

Lepton conservation: sample reactions revised

The neutrino is a spin- $\frac{1}{2}$ fermion. I said back on page 10 that every fermion had a twin: a so-called “antiparticle” with the same mass, same spin, and same magnitude but opposite sign of electrical charge. This means that there is not just a neutrino, but an antineutrino.

Furthermore, electrons and neutrinos are members of a class of fermions called “leptons”. It turns out that lepton number is conserved: Leptons can be created, but every time you create a lepton you have to create an antilepton at the same time. Similarly for destruction.

With this knowledge, we see that the example of beta decay we started with on page 10,

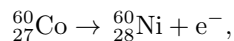

can't be correct: the charge is the same on both sides, but lepton number increased by one when the electron was created. The real beta decay reaction is

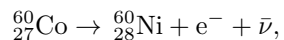

where $\bar{\nu}$ represents an antineutrino. In this reaction one lepton (the e^{-}) is created, but one antilepton (the $\bar{\nu}$) is also created, so lepton number is conserved. Neutrinos are so hard to detect that it was decades before the reaction written on page 10 was corrected to the reaction shown above.

What about the other reactions listed on page 10? The beta plus decay is actually

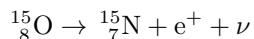

while the electron capture is in reality

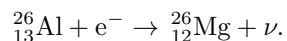

Chapter 4

Nuclear Stability

[[Caution:

For “energy eigenvalue”, don’t use “energy level”.

For “mean energy well”, don’t use “effective potential energy function”.

I was trained using this bad terminology. I try to avoid it, but one of these familiar bad phrases might slip out of my mouth while teaching. Feel free to jump on me if it does.]]

The weak interaction resolves the questions about nuclear stability raised on pages 11 and 12: Why do light stable nuclei have about as many neutrons as protons? Why do heavy stable nuclei have more neutrons than protons? Why isn’t a nucleus of only neutrons stable?

We noted (in connection with the atomic Helium problem) that we don’t yet have an exact analytic solution for the classical three-body problem, so of course we don’t yet have one for the quantal three-body problem. But the situation for understanding nuclei is worse than that:

For atoms:

The interaction between electrons and nucleus is the known Coulombic interaction.

The electrons are far apart.

Correlations between electrons can be ignored to first approximation.

For nuclei:

The interaction between nucleons is not known — the Reid potential is approximate.

The nucleons are close-spaced.

Correlations between nuclei can't be ignored.

Does this mean we should give up? No way! In the absence of perfect understanding, some understanding is better than no understanding.

We can make progress through the “mean field approximation”: For six nucleons, instead of looking at $\frac{1}{2}6(6 - 1) = 15$ nucleon-nucleon interactions, look at a single nucleon interacting with the average of the other five nucleons.

Now, we can't actually know how the “average of all the other nucleons” behaves. But we do know, from experiment, that some nuclei are stable, so there must be some sort of attractive potential energy function. In the absence of any sort of detailed procedure to find it, I'll just represent it by a square well — that's the easiest potential energy function to draw.

For a light nucleus, the average potential energy function felt by a proton is nearly the same as that felt by a neutron, because the strong force treats protons and neutrons identically, and there are so few protons that electrostatic repulsion is minor. (We will return to consider heavy nuclei later.)

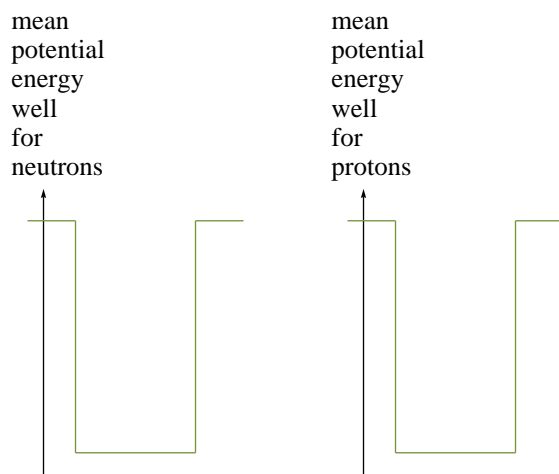

Now, since we don't actually know the average potential well, we of course can't find the energy eigenvalues. But we *do* know that energy eigenvalues exist. I'll just draw in some energy eigenvalues. I space them evenly not because they're evenly spaced, but because (again) that's the easiest thing to draw. There might actually be a degeneracy, in which case the separation between eigenvalues is zero. What's important is that the energy eigenvalues for neutrons are the same as those for protons.

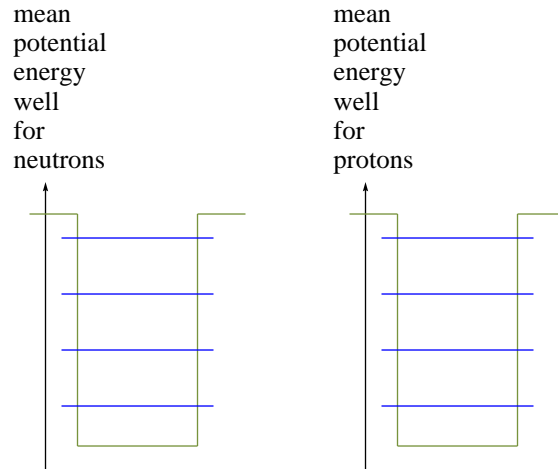

Now comes the task of building many-particle states out of the one-particle levels. Just as an example, suppose there are 7 neutrons and 5 protons (this nucleus is $^{12}_5\text{B}$). Following convention, I'll mark the levels (with spin) that are incorporated and antisymmetrized into the many-particle ground state.¹

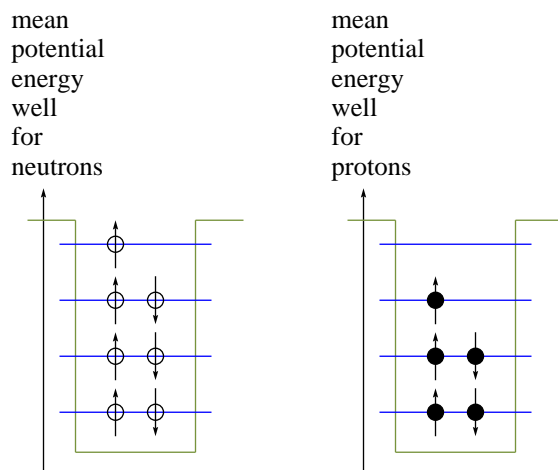

While this diagram represents the ground state for $^{12}_5\text{B}$, there's a lower energy available. If one of the neutrons could turn into a proton, then, instead of using the fourth energy eigenvalue to build up a seven-body neutron state, it could use the third energy eigenvalue to build up a six-body proton state, which would have an energy even lower than the ground energy of $^{12}_5\text{B}$.

¹Avoid the misconception that different identical particles reside in different levels. This diagram doesn't show different particles in different levels: if the particles were "different", they would not be identical. Instead it marks the levels that are incorporated into the many-particle ground state. The circles in the figure represent levels, not particles.

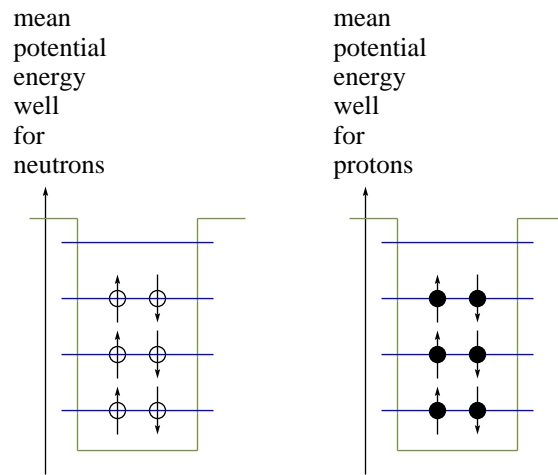

You might object: “Sure, but you can’t turn a neutron into a proton.” And indeed you can’t do it through the strong interaction. But you *can* do it through the weak interaction reaction

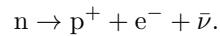

We have just predicted that $^{12}_5\text{B}$ will decay into $^{12}_6\text{C}$ through beta decay:

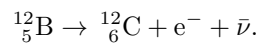

And sure enough, that’s exactly what happens: $^{12}_5\text{B}$ is not stable. It is a radioactive beta emitter, and it decays, with half-life 0.0202 s, into the stable nucleus $^{12}_6\text{C}$. (These data come from the NUBASE2016 database mentioned in the footnote on page 11.)

We have uncovered the key to nuclear stability for light nuclei. If there are a lot more neutrons than protons, then a lower energy ground state can be obtained by turning a neutron into a proton through beta decay. If there are a lot more protons than neutrons, then a lower energy ground state can be obtained by turning a proton into a neutron through beta plus decay (or through electron capture). A stable nucleus will have about as many protons as neutrons. A nucleus of pure neutrons is not stable: it will disintegrate through beta decay.

What about heavy nuclei? In this case with many protons, electrostatic repulsion is more important. But this repulsion affects only protons, so the average potential well for protons is *shallower* than the average potential well for neutrons. Once that realization is made, the energy eigenvalues can be drawn and the levels built into states as before. This diagram shows the results for 15 neutrons and 11 protons: ${}_{11}^{26}\text{Na}$.

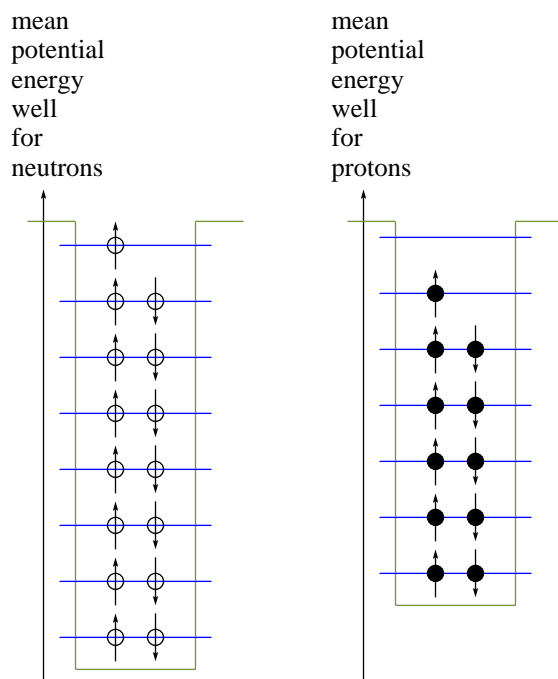

The same reasoning as before suggests that this nucleus will decay through

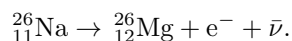

Sure enough, the nucleus ${}_{11}^{26}\text{Na}$ beta decays, with half-life 1.07 s, into the stable nucleus ${}_{12}^{26}\text{Mg}$.

For a large stable nucleus, there will be more neutrons than protons. We have successfully explained, in a qualitative way, the challenges posed on pages 11 and 12.

When I was an undergraduate, I despised the sort of qualitative reasoning used in this chapter. I wanted every problem to be solved completely in closed form with an equation, the way trajectory problems were solved. I realize now that my desire as an undergraduate was misguided for three reasons: First, many interesting problems are simply not solvable in closed form. Second, even those problems that are “solved in closed form” are solved only by setting up a model. For example the

trajectory problems I held up as ideals were “solved in closed form” only because they ignored the curvature of the earth, the diminution of gravitational acceleration as height increases, relativity, air friction, etc. Finally, I was seeking to turn problem solving into a mechanical process: Turn the crank, solve the ordinary differential equation, I’m done. Why think? Let the mathematical machinery do the thinking for me. But in fact it’s much more exciting and much more profitable to think, to see what nature is trying to teach me through a problem. “I went to the woods” writes Thoreau, “because I wished to live deliberately, to front only the essential facts of life, and see if I could not learn what it had to teach, and not, when I came to die, discover that I had not lived. . . . I wanted to live deep and suck out all the marrow of life.”

Problems

- 4.1 **Lithium.** Is the nucleus ${}^8_3\text{Li}$ stable or unstable? If unstable, how does it decay? Explain how you know. Repeat for ${}^8_4\text{Be}$ and ${}^{11}_4\text{Be}$.
- 4.2 **Questions.** This document has presented a number of facts about nuclei and explained only a few of them. In your mind, which remaining facts most urgently require explanation?

[[For example, I would list: “I would like an approximate formula for the curve of stability shown shown on page 11.” “I would like an explanation for alpha decay, culminating in an approximate formula for the half-life of nuclei that disintegrate through alpha decay.”]]

Chapter 5

Balance of Masses

Sample Problem: ${}_{18}^{37}\text{Ar}$ (atomic mass 36.966 776 u) decays to ${}_{17}^{37}\text{Cl}$ (atomic mass 36.965 903 u). Does this process happen through β^+ decay (ejection of a positron) or through electron capture? *Clue:* The electron has mass 0.000 549 u. The neutrino's mass is unknown, but less than 2×10^{-6} times the mass of an electron.

The fundamental reaction in β^+ decay is

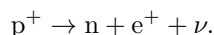

If this reaction happens inside the nucleus of a ${}_{18}^{37}\text{Ar}$ atom, then it leaves the atom with 18 electrons and 17 protons. That is, it leaves the atom as a Cl^- ion. In sum, the β^+ process is

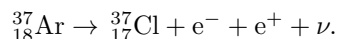

The fundamental reaction in electron capture is

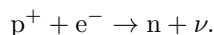

If this reaction happens inside the nucleus of a ${}_{18}^{37}\text{Ar}$ atom, then it leaves the atom with 17 electrons and 17 protons, which is a neutral Cl atom. In sum, the electron capture process is

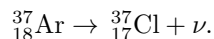

Because the neutrino has zero mass to the number of significant digits used here, the balance of masses is:

β^+ decay: mass of Ar atom vs. mass of Cl atom + 2 \times mass of electron

$$36.966\,776\text{ u} \text{ vs. } 36.965\,903\text{ u} + 2(0.000\,549\text{ u}) = 36.967\,001\text{ u}$$

electron capture: mass of Ar atom vs. mass of Cl atom

$$36.966\,776\text{ u} \text{ vs. } 36.965\,903\text{ u}$$

Thus, energy conservation prohibits β^+ decay but permits electron capture.

Chapter 6

Elementary Particles

This course has largely been a story of “inward bound”. We started with a wavelength of light, which seemed small. But then we found that atoms were smaller still, and nuclei are smaller again. There are other physics stories. There’s the story of “outward bound”: planets to stars to black holes to galaxies to the cosmological structure of spacetime. And there’s my favorite, the story of “increasing complexity”: atoms to molecules to solids and fluids in bulk, to superfluids and superconductors, Bose condensate and Fermi condensate, ferromagnets and antiferromagnets, quasicrystals and plasmas and liquid crystals. These story threads intertwine and strengthen each other.

But for this last chapter, we take one last step on the “inward bound” journey. A person is made up of organs. Organs are made up of tissues. Tissues are made up of cells, cells of molecules, molecules of atoms, atoms of electrons and nuclei, nuclei of protons and neutrons. At the end of this progression, as far as we know today, are the so-called “elementary particles”.

This chapter summarizes the “standard model” of elementary particle physics. It cannot, in eleven pages, even touch upon the copious experimental evidence and theoretical reasoning that undergirds this model. But one fact alone demonstrates that such evidence and reasoning exists: no human being — not J.K. Rowling, not J.R.R. Tolkien, not even William Shakespeare — would invent a scheme so baroque and unexpected and imaginative as the one presented here.

Data largely from the Particle Data Group, an international collaboration headquartered at Lawrence Berkeley National Laboratory in Berkeley, California. (<http://pdg.lbl.gov/>)

What is an elementary particle?

In classical mechanics, a “particle” is an infinitely small and infinitely hard dot. Even in non-relativistic quantum mechanics, this definition is untenable, because an infinitely small, infinitely hard dot has an exact position and simultaneously an exact momentum. In elementary particle physics, a “particle” is even further from the commonsense picture: it is an energy eigenstate of a field energy. Thus one can find a linear superposition of two particles, a feat unimaginable for classical particles. Indeed, the 2015 Nobel Prize in Physics was awarded for research into linear combinations of the electron neutrino and the muon neutrino.

Antiparticles

Some particles come in pairs. For example, paired with the familiar electron is the unfamiliar “positron” or “antielectron” with the same mass, the same spin, the same magnitude of electrical charge but the opposite sign of electrical charge. The choice of name is poor: There is nothing “anti” about the positron, and nothing “pro” about the electron: the positron is merely less common and hence less familiar.

If an electron and positron approach, the two can “annihilate” destroying both the electron and the positron, but generating a pair of photons. Energy is conserved in this process, so if they approach with kinetic energy negligible relative to their rest energies, then each of the exiting photons will have energy 0.511 MeV. If they come together with sufficient energy, they can actually annihilate and produce a new particle-antiparticle pair, such as a proton and an antiproton.

Charge and color

“Charge” is the source of electromagnetic force, “color” (or “color charge”) is the source of strong force. Charge and color are conserved.

Elementary fermions

Each of these elementary fermions has spin- $\frac{1}{2}$. For each particle there is an associated antiparticle.

The mass is given below the name of the particle, in MeV/c^2 . (Except for neutrinos.) The charge is given in terms of the proton's charge.

Leptons

There is a particle just like the electron — same charge, same spin — but 207 times more massive. It is called the muon. Just as the electron has an accompanying antiparticle called a positron, so the muon has an accompanying antiparticle called an antimuon. Just as the electron has an associated neutrino and antineutrino, the muon has its own associated muon neutrino and muon antineutrino.

Furthermore, this entire story is repeated: there is a particle called the tau just like the electron but 3477 times more massive.¹ The tau comes with its own antitau, its own associated neutrino, and its own associated antineutrino.

Lepton number (number of leptons – number of antileptons) is conserved.

			charge	color
τ 1777	μ 106	e 0.511	-1	0
ν_τ ?	ν_μ ?	ν_e < 1.1 eV	0	0

Evidence suggests² that the sum of the masses of the three types of neutrinos is

$$m_{\nu_\tau} + m_{\nu_\mu} + m_{\nu_e} < 0.26 \text{ eV}.$$

Quarks

Quark number (number of quarks – number of antiquarks) is conserved. Each quark comes in three colors (red, green, and blue).

			charge	color
b 4180	s 93	d 4.7	-1/3	1
t 172 000	c 1275	u 2.2	+2/3	1

¹I still remember vividly the day in 1977 when I first heard of the tau's discovery. I had just been offered my first full-time physics job. What excitement!

²Arthur Loureiro, Andrei Cuceu, Filipe B. Abdalla, Bruno Moraes, Lorne Whiteway, Michael McLeod, Sreekumar T. Balan, Ofer Lahav, Aurélien Benoit-Lévy, Marc Manera, Richard P. Rollins, and Henrique S. Xavier, "Upper bound of neutrino masses from combined cosmological observations and particle physics experiments" *Physical Review Letters* **123** (22 August 2019) 081301.

The six different kinds (“flavors”) of quark are called “down”, “up”, “strange”, “charm”, “bottom”, and “top”.

Quark combinations

We never see free quarks. In fact we never see free colored particles. This so-called “color confinement” is discussed in the subsection “Strong interaction”.

A proton is the quark combination uud . The mass of a proton is $938 \text{ MeV}/c^2$. The sum of the masses of its constituents is $9.1 \text{ MeV}/c^2$. Most of the mass of a nucleon (and hence most of the mass of a person) is due to field or kinetic energy, not due to the mass of the nucleon’s (or the person’s) quarks.

Combinations of two quarks (“mesons”):

The π^+ meson is $u\bar{d}$.

The π^0 meson is $\frac{1}{\sqrt{2}}(u\bar{u} - d\bar{d})$.

The π^- meson is $\bar{u}d$.

Combinations of three quarks (“baryons”):

The proton is uud .

The neutron is udd .

The Λ^0 is uds .

The Σ^+ is uus .

The Δ^- is ddd .

The Δ^0 is udd . (Same ingredients as neutron, but different arrangement hence different mass.)

The Δ^+ is uud .

The Δ^{++} is uuu .

Tetraquarks (discovery announced 25 June 2016 by LHCb at CERN):

$c\bar{s}\bar{c}s$

Pentaquarks (discovery announced 13 June 2015 by LHCb at CERN):

$uudc\bar{c}$

Elementary bosons

These elementary bosons don't have antiparticles. Masses are given in MeV/c^2 .

Gauge bosons (spin-1)

	carries	number	mass	charge	color
photon	em force	1	0	0	0
gluon	strong force	8	0	0	$-i(\bar{r}\bar{b} - \bar{b}\bar{r})/\sqrt{2}$, etc.
W^\pm	weak force	2	80 379	± 1	0
Z^0	weak force	1	91 188	0	0

Other bosons

	mass	charge	color	spin
graviton	0	0	0	2
Higgs boson	125 100	0	0	0

What do these elementary particles do?

Every printed play begins with a “dramatis personae”: a list of the characters in that play. The character list is not particularly interesting. It's what the characters do that makes the play worth watching.

Similarly, to make this list of elementary particles interesting we have to ask what they do.

Move from place to place

To keep things relatively straightforward, we'll ignore the polarization of a photon or the spin of any massive particle: these are called “Klein-Gordon particles”. The simplest thing such a particle can do is to move from place \vec{x}_a at time t_a to place \vec{x}_b at time t_b . (If it were an electron instead of a Klein-Gordon particle, we'd have to ask instead about motion from place \vec{x}_a at time t_a with spin up to place \vec{x}_b at time t_b with spin 17° .) The initial event is four-vector \mathbf{r}_a represented in frame F by $\mathbf{r}_a \doteq [ct_a, \vec{x}_a]$. Similarly for the final event.

The “amplitude to go from initial event \mathbf{r}_a to final event $\mathbf{r}_b = \mathbf{r}_a + \Delta\mathbf{r}$ ” must be frame independent, so it can depend only on four-scalars like

$$(\Delta\mathbf{r})^2 = (c\Delta t)^2 - (\Delta\vec{x})^2.$$

As always in quantum mechanics, there are many paths from initial to final state and some amplitude to take any path. Each path is characterized by a four-momentum $\mathbf{p} \doteq [E/c, \vec{p}]$. Recall that

$$\mathbf{p} \cdot \Delta\mathbf{r} = (E\Delta t) - (\vec{p} \cdot \Delta\vec{x})$$

is also a four-scalar. The amplitude density to take this path from initial to final is³

$$A(\mathbb{p}, \Delta\mathbf{r}) = \frac{1}{(2\pi)^4 \hbar^2} \frac{e^{i\mathbb{p} \cdot \Delta\mathbf{r} / \hbar}}{\mathbb{p}^2 - (mc)^2 + i\epsilon}$$

where m is the mass of the particle (zero for a photon) and ϵ is a small positive number that prevents explosions when $\mathbb{p}^2 = (mc)^2$ but that will approach zero at the end of any calculation.

The total amplitude to go from initial to final is just the sum (integral) of this amplitude over all possible paths

$$G_F(\Delta\mathbf{r}) = \int A(\mathbb{p}, \Delta\mathbf{r}) d^4p.$$

Electromagnetic interaction

Two electrons start out in two positions. What is the probability that, after some time has passed, they end in the same positions?

You know the drill of quantum mechanics: There are many ways to go from the initial state to the final state. There is an amplitude for each way. Sum all the amplitudes and the probability is the square of the magnitude of that sum.

Four of the infinite number of “ways to go from initial to final state” are sketched below. The two electrons could do nothing. Or they could move around and end up where they started. Or one electron could move from its initial position, then emit a photon (shown as a green line), then move back to its initial position, while the other moves, absorbs that photon, and then moves back.⁴ (It’s also possible for one electron to emit a photon that is not absorbed by the second electron, but then the final state is different, so the amplitude for this process doesn’t enter into the sum.) Or there could be two photons exchanged.

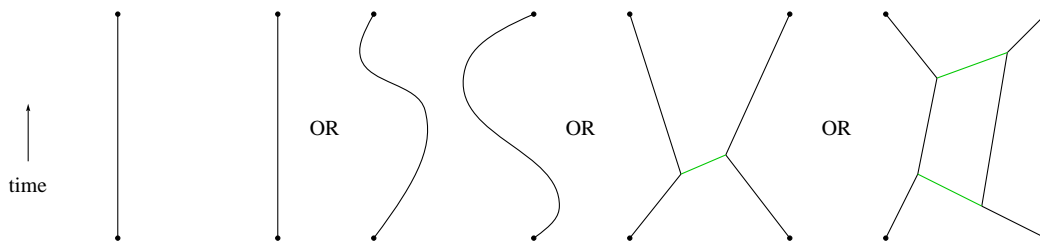

³See, for example, Claude Itzykson and Jean-Bernard Zuber, *Quantum Field Theory* (McGraw-Hill, New York, 1980), page 35, equation (1-178).

⁴How does this process accord with the classical theorem that a free electron can neither emit nor absorb a photon? Remember that this alternative doesn’t *happen*, instead it *contributes an amplitude toward what happens*.

There are rules for assigning amplitudes, and mathematical techniques for performing the summation (actually the integration, because there are a continuum of ways). You'll learn these rules and techniques when you study quantum electrodynamics. For now, what's important to know is that the concepts of electric and magnetic field are the manifestations of photon exchange when many photons are present in the classical limit.

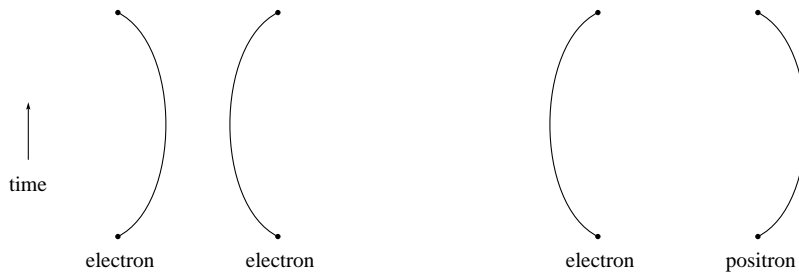

For example, in the situation above with two electrons beginning and ending at the same place, it turns out that, in the classical limit, the “ways” making the most important contributions to the sum are like those in the figure on the left, showing the classical Coulombic repulsion of the two negatively charged electrons. (The green photon trajectories are not shown, because there are millions of them.) If the situation had instead been one electron and one positron beginning and ending at the same place, then in the classical limit the most important contributors would have been like those on the right, showing the classical Coulombic attraction of the negatively charged electron and the positively charged positron.

There is a misconception that the photon is made up of electric and magnetic fields. In fact, it's the other way around: electric and magnetic fields are classical approximations legitimate only when vast numbers of photons are present.

Strong interaction

The strong interaction is in many respects similar, but is intermediated by gluons rather than photons. A typical “way” is

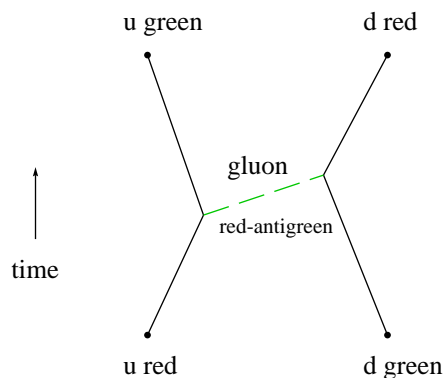

The source of electromagnetic force is called electric charge. For historical reasons, the source of strong force is called “color” (or sometimes “color charge”). There is only one kind of electric charge, and it comes in both $+$ and its opposite $-$. There are three kinds of color charge — red, green, and blue — and just like electric charge color charge comes with opposites — anti-red, anti-green, and anti-blue. The theory of electromagnetism is called quantum electrodynamics (QED). The theory of the strong force is called quantum chromodynamics (QCD).

The big difference between the strong force and the electromagnetic force is that gluons are colored whereas photons are electrically neutral. Thus strong field is colored and is itself a source of strong field, whereas electromagnetic field is electrically neutral and is not a source of electromagnetic field. This gives rise to obvious mathematical headaches, but also to a host of new phenomena, the most important of which is color confinement. The rest of this subsection gives a hand-waving “explanation” of color confinement.

You know that if you bring together a positive and a negative electric charge, then (in the classical limit) they produce electric field lines like those sketched here (figure courtesy of Geek3).

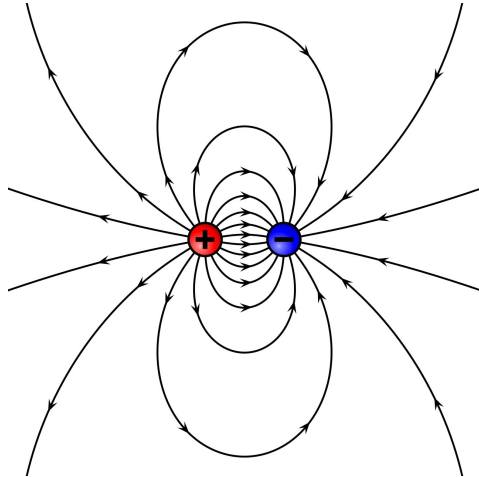

If you bring together a blue and an anti-blue quark, say to make a π^+ meson, the classical-limit field lines attract one another: instead of spreading out through space as above, they collapse into a “QCD flux tube” (or “QCD string”) like this one



The force attracting the two quarks, called the “tension” κ , is very strong: once they are separated by a distance of a femtometer or so, the force is about 160 000 N regardless of how far apart the two are. (Much stronger even than the nucleon-nucleon “residual strong force” of 25 000 N mentioned on page 6.) So it takes a lot of energy to pull the two quarks apart. Pretty soon, there’s enough energy around that it becomes energetically favorable to pop an anti-blue plus blue pair out of the vacuum

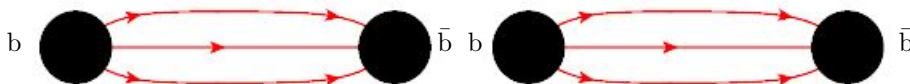

This pair creation does not violate any conservation laws: the quark and antiquark created are of opposite color charge and opposite electrical charge. So the process

starts with one colorless particle and ends with two colorless particles: at all times there is no net color and “color confinement” holds.

Weak interaction

Back when neutrons and protons were thought to be elementary particles, it was thought that neutron decay $n \rightarrow p^+ + e^- + \bar{\nu}$ proceeded through a diagram like this:

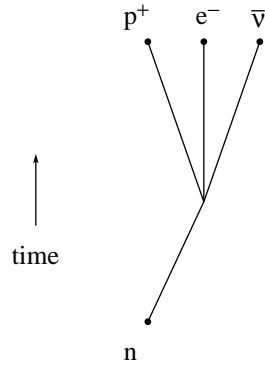

Today we know that the decay happens in two stages: first one d quark within the neutron emits a W^- and turns into a u quark, whence the neutron turns into a proton. Very soon thereafter the W^- decays into an electron and an antineutrino:

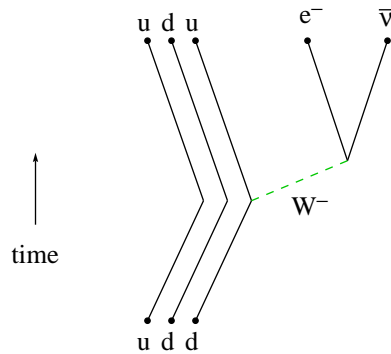

The big difference between the weak force and the electromagnetic force is that the W^\pm and the Z^0 are massive whereas photons are massless. The short-range character of the weak force is a (non-obvious) consequence of this mass.

Gravitational interaction

We have a classical relativistic theory of gravity (general relativity) and we have a quantal theory of non-relativistic gravity (in which gravity works by the exchange of gravitons), but we don't yet have a quantal relativistic theory of gravity. String theory is one attempt to find one; loop quantum gravity is another. There are other attempts as well.

In Newton's non-relativistic gravity, the source of gravity is mass. In Einstein's general relativity, the source of gravity is mass, or energy, or momentum, or the flow of mass, energy, or momentum. (Technically, this source is called the "the stress-energy tensor".) This explains how the path of a massless photon can be bent by gravity.

Chapter 7

Epilogue

The properties and interactions of nuclei and elementary particles may seem strange to you — they do to me.

But through history many things have seemed strange: When Joseph Black (1728–1799) discovered the chemical reaction $\text{CaCO}_3 \rightarrow \text{CaO} + \text{CO}_2$, one of his contemporaries¹ wrote in astonishment that

He had discovered that a cubic inch of marble consisted of about half its weight of pure lime, and as much air as would fill a vessel holding six wine gallons. . . . What could be more singular than to find so subtle a substance as air existing in the form of a hard stone, and its presence accompanied by such a change in the properties of that stone? . . . It is surely a dull mind that will not be animated by such a prospect.

All the actors and actions of nuclei and elementary particles, strange though they may seem, fall solidly within the framework of relativity and quantal amplitudes developed in this course.

¹John Robison, in the preface to Joseph Black, *Lectures on the Elements of Chemistry* (Mundell and Son, Edinburgh, UK, 1803) volume 1, pages xxvi–xxix.

Index

Amaldi, Edoardo, 14

antiparticle, 10, 14, 18, 28–36

Auger, Pierre Victor, 9

Black, Joseph, 38

Bohr, Neils, 13

Chadwick, James, 14

Cowan, Clyde, 14, 17

Fermi, Enrico, 14

Hahn, Otto, 13

Meitner, Lise, 9, 13

misconceptions

- a particle is an infinitely small and infinitely hard dot, 28

- all radioactivity is equally deadly, 10

- classical conservation laws apply to every permissible quantal alternative, 32

- identical particles reside in different levels, 22

- life is fair, 9, 14

- nucleons are marbles, 5

- photon is made up of electromagnetic fields, 33

- physics terminology is sensible and consistent, 6

- the source of gravity is mass alone, 37

- there is something “anti” about antiparticles, 28

Pauli, Wolfgang, 13

Reines, Fred, 14, 17

Rutherford, Ernest, 4

Yukawa, Hideki, 5